



TOOLS SYSTEMS & ACCESSORIES

2025
ONGOING

WWW.BYRNETOOLS.COM

CONTACTUS

Byrne (Tianjin) Technology Co., Ltd.
E-mail: byrne@vip.163.com



Byrnetools Workbench BN-F/B

- Fold and stretch within a second
- Made of top quality materials
- Variety size of 6/9/10/12/15 stands, load limit over 1 ton.
- Pre-drilled holes on the nodes for table fixing
- Variety accessories

The best fast cutting tools for track saw

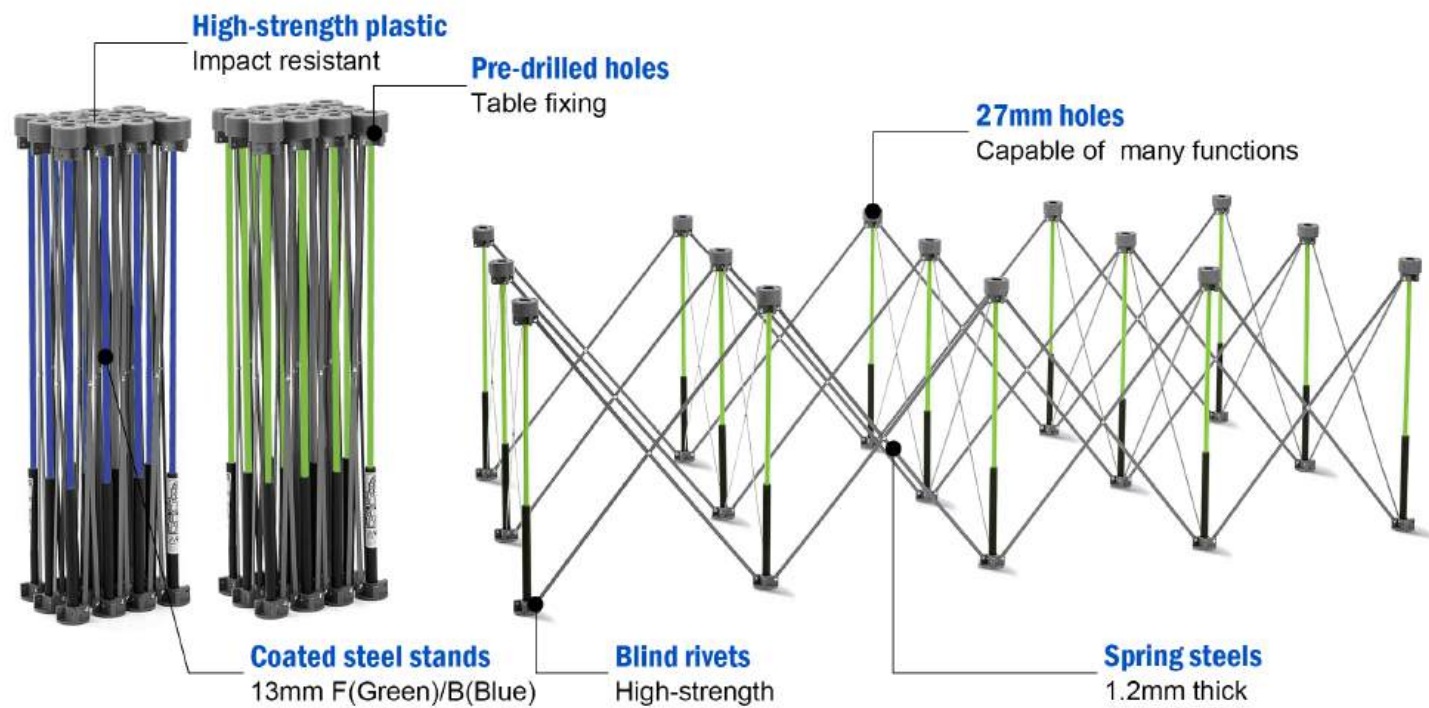

BN-F6-15S BN-B6-15S

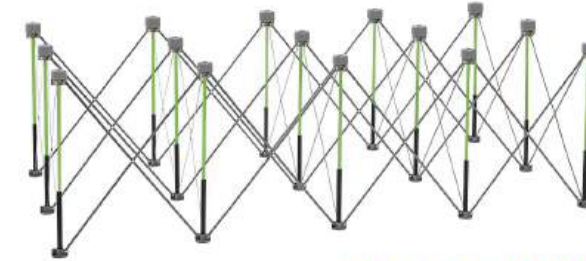

* Includes a bag / a holder set

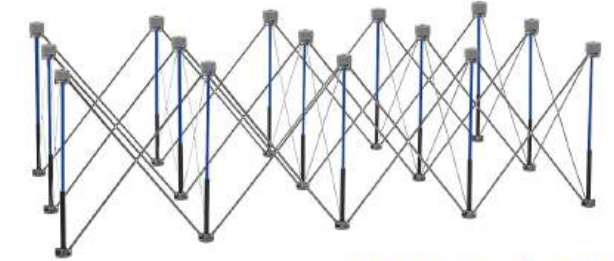

* Includes a bag / a holder set

SKU/Green	SKU/Blue	Stands	Stretch Size	Folding Size	Weight	Load
BN-F6S	BN-B6S	6	0.6*1.2m	130*195*940mm	4.55kg	1000kg
BN-F9S	BN-B9S	9	1.2*1.2m	195*195*940mm	7.4kg	1500kg
BN-F10S	BN-B10S	10	0.6*2.36m	130*325*940mm	7.55kg	1000kg
BN-F12S	BN-B12S	12	1.2*1.75m	195*260*940mm	10kg	1600kg
BN-F15S	BN-B15S	15	1.2*2.36m	195*325*940mm	12.5kg	2000kg



TRACK HOLDER SET BN-GG13 HANGER BN-PJ5



Model #	Description
180703	3PC * track holder, 13mm pipe size



Model #	Description
181175	1PC, throat 88mm, height 145mm

SHELF BN-PJ1 SUPPORTING NODE BN-PJ4 LEVELING NODE BN-PJ2



Model #	Description
181182	1PC. 162x210mm



Model #	Description
181199	4PC nodes for storing



Model #	Description
181205	1 SET node for leveling



Track Saw Vgroove/Multi-Slot Blade Set VT 55 CN

- FESTOOL TS55/TSC55 quick blade switch
- Consistent 90° angle cuts with Vgroove blade
- 3 or 5 slot cut options with Multi-Slot blade
- On-site drywall design
- Enhances efficiency and delivers the top finish

Fit : FESTOOL TS 55 / TSC 55



VT 55 CN MAX | **VT 55 V-GROOVE SET**



Model #	Description
181151	Vgroove blade+Multi-slot blade+Case cover

Model #	Description
180222	Vgroove blade+Case cover

VT 55 THREE SLOT SAW SET | **V-GROOVE**

* Replaceable blade



Model #	Description
180246	Multi-slot blade+Case cover

Model #	Description
181168	120x27x20mm

125-3/5-PC SET | **BN 125x1.5x20 W24** | **VGROOVE REPLCEMENT**



Model #	Description
181144	125x1.5x20/3/5PC

Model #	Description
181137	125x1.5x20mm 24T

Model #	Description
180857	4 pcs*triangle blades + 2 pcs*square blades



HOLE SAW BE-TCT



- Large disposal holes
- Alloy blades
- Cutting through nails
- Super durable
- Clean cut finish
- Wood/drywall/plastic

Model	Size	Height	Hole Depth	Thread Size
180260	35mm	70.3mm	54mm	5/8-18P
180635	60mm	64.8mm	54mm	5/8-18P
180895	75mm	64.8mm	54mm	5/8-18P
180901	80mm	64.8mm	54mm	5/8-18P

HOLE SAW MANDREL BE-686QRS

DUST COLLECTOR BE 686-4

Quick Release Hole Saw Mandrel BE-686QRS

- Quick waste release function
- TCT alloy blades increase sharpness and durability
- Wood/drywall/plastic
- Accurate concentric alignment
- Vibration-free experience
- Large disposal holes

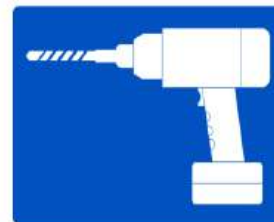

Model #	Description
180253	Shank12mm, 1PC*mandrel+1PC*drill bit

Model #	Description
181229	1PC, Size 150mm



DRILL BIT BE 686-2

DRILL CONNECTOR BE 686-1

DRILL ADAPTER BE 686-3



Model #	Description
181212	6.35mm*104mm

Model #	Description
181236	Thread size 15mm

Model #	Description
181243	Shank size 9.5mm



F CLAMP BN-F6-36

- Reverse the head for supporting work
- Sturdy nylon fiberglass
- One hand operation
- Quick depth adjustment
- Surface protection
- 150KG Grip power



Clamp BN-F/C

- F clamp with Heavy duty and quick release
- C clamp with simple grip and quick release
- Plastic chuck protects workpiece surfaces
- F/C clamps feature sturdy, lightweight nylon fiberglass
- F ratchet clamp offers strong grip for rails and pegboards

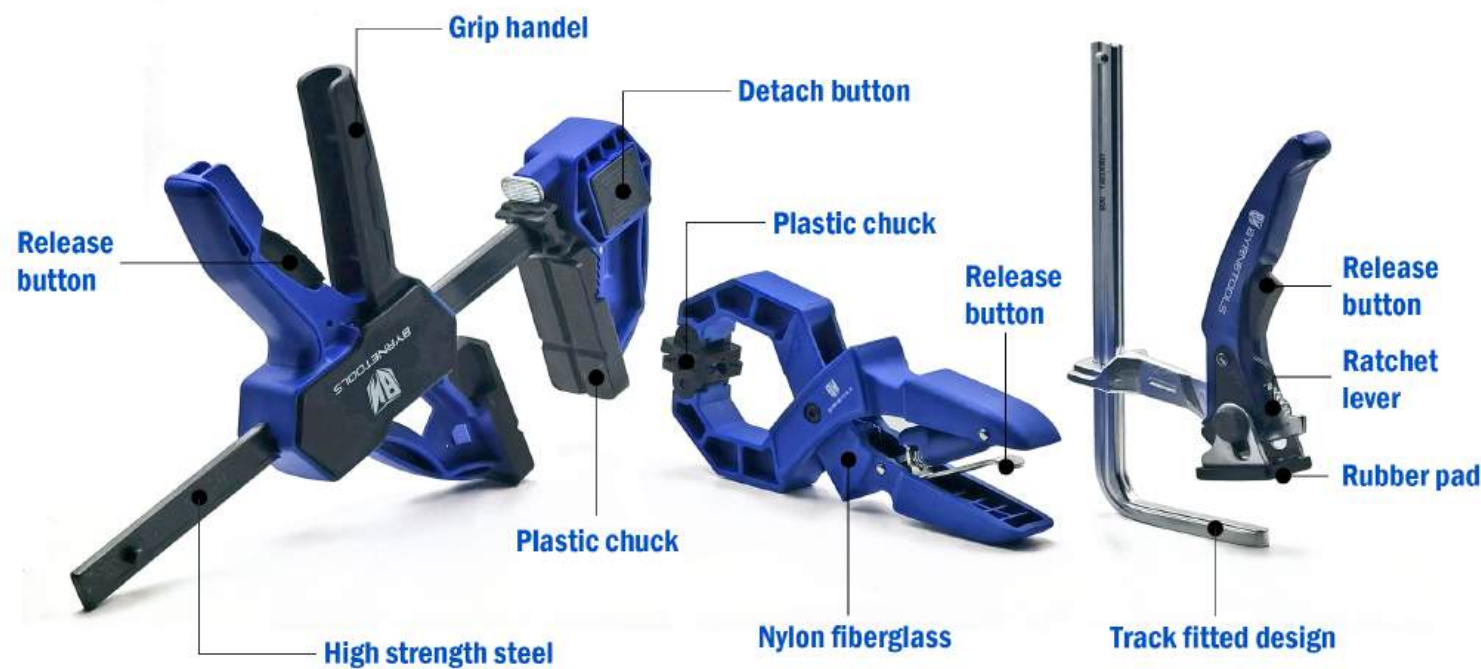

C CLAMP BN-C7

F RATCHET CLAMP BN 160X60



Model #	Description
180369	Depth0-50mm, throat60mm, size200mm

Model #	Description
180680	Size60*160mm, steel size12x8mm

Model	Spec	Holding Depth	Holding Throat	Clamping Force
180383	BN-F6	150mm	80mm	150kg
180390	BN-F12	300mm	80mm	150kg
180406	BN-F18	450mm	80mm	150kg
180413	BN-F24	600mm	80mm	150kg
180420	BN-F36	750mm	80mm	150kg

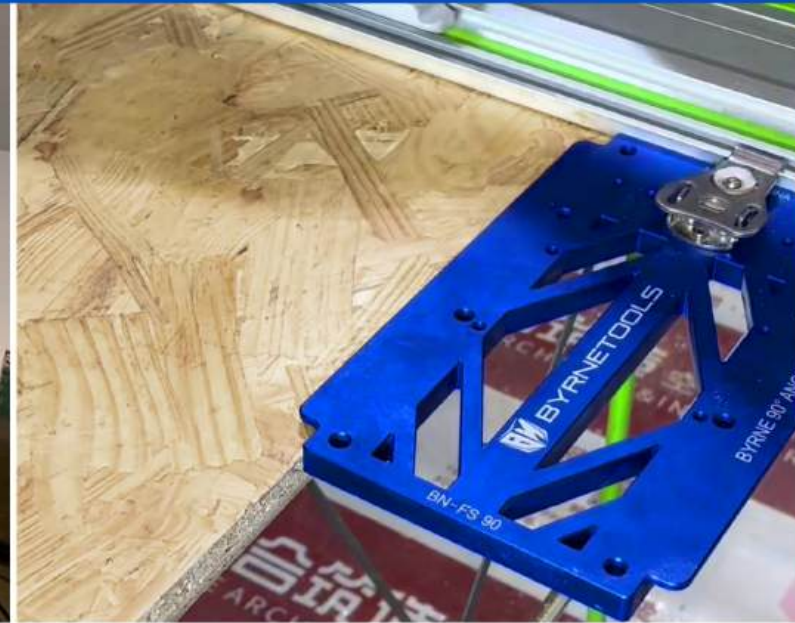

Track Saw Square Hinge System BN-MFT-FS

- Quick assembly for any woodworking bench
- Micro fine adjustment for repetitive wood cutting
- Leverage mode and lift mode
- Requires woodworking square
- Compatibal: Festool/Makita/Milwaukee/Bosch/Mafell/Dewalt/others



Model #	Description
180536	1PC*Leverage set, 1PC*lock set, 1Set*Installing kit, 2PC*Saw stop

Track Square Stop BN-FS 90

- 90-degree precise cutting
- Easy installation
- Pre-drilled holes for expanding more functions
- Compatibal: Festool/Makita/Milwaukee/Bosch/Mafell/Dewalt/others

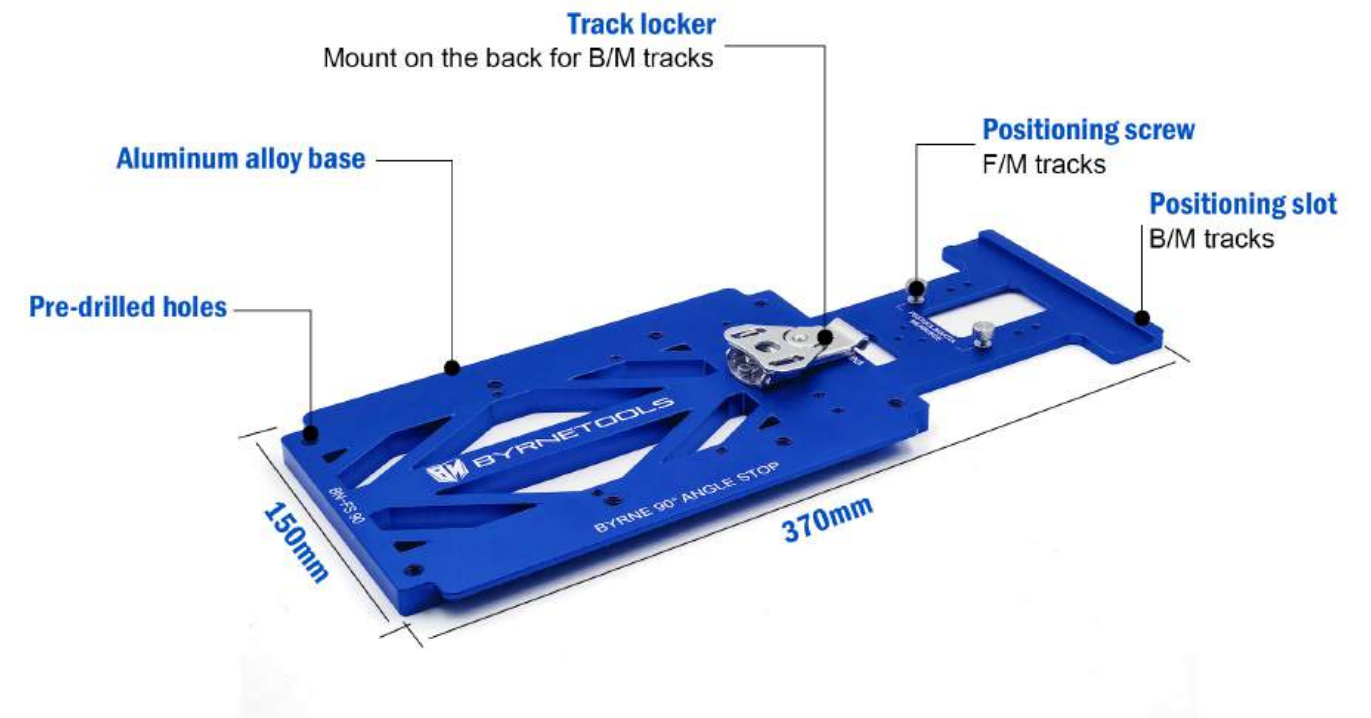

Model #	Description
180963	370x150mm

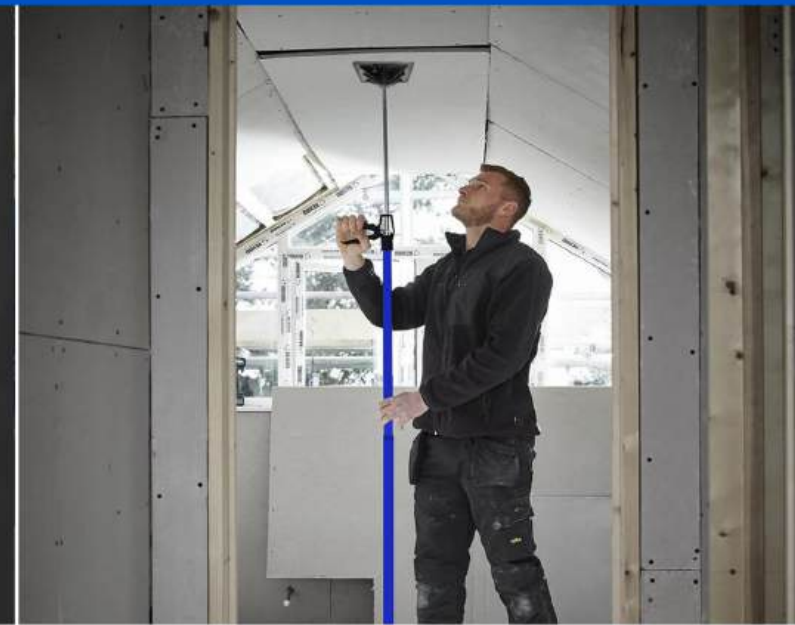

3rd Hand Suppoter BN1

- Single supporter load limit of 30kg
- Short 50-115cm, for supporting the installation of wall cabinets and wooden door frames
- Long 115-290cm, for supporting drywall work on ceiling
- 75x125mm swivel support pads, 45-degree rotation for various angles
- Press to lift, push to return

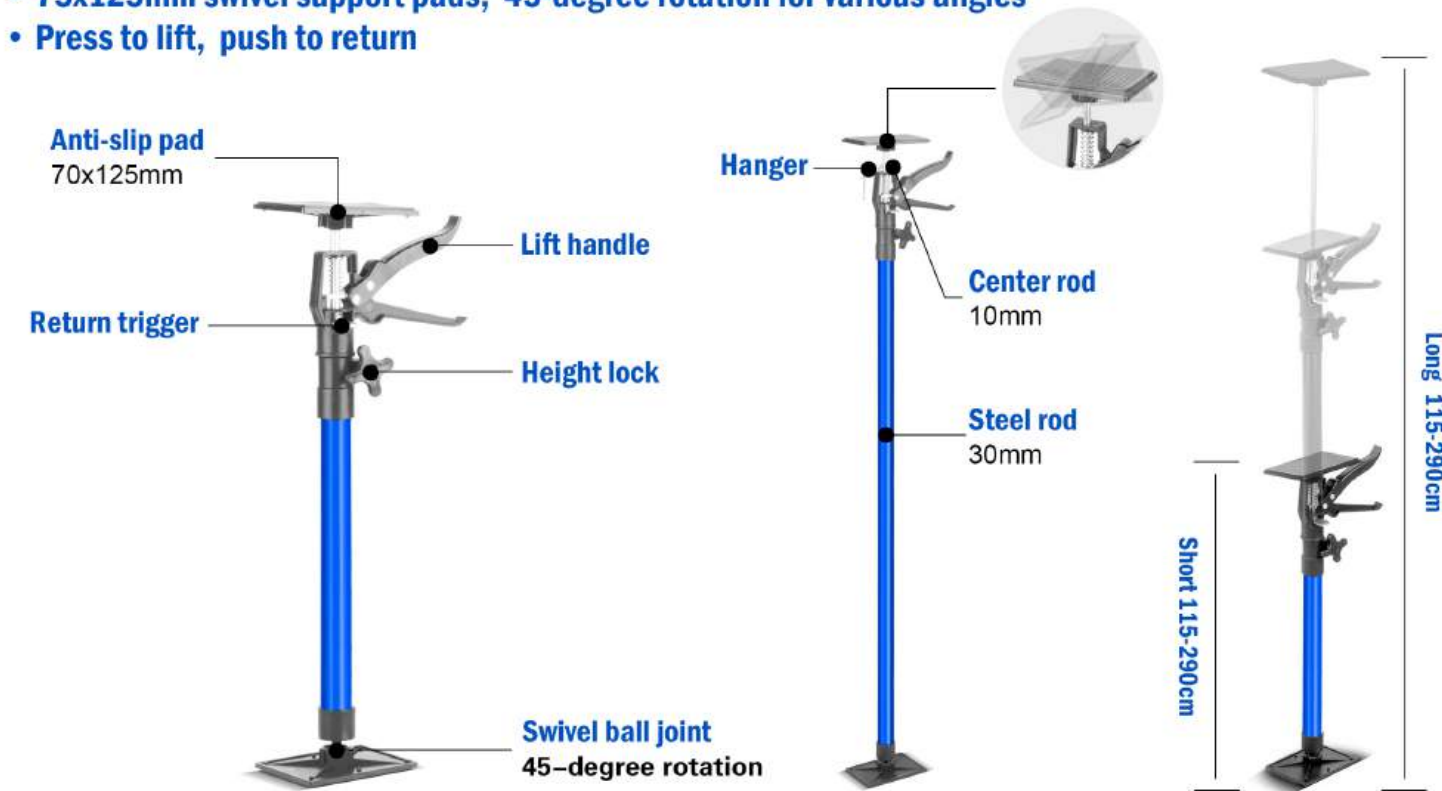

Model #	Spec	Description
180277	BN1-50-115CM	2PC, 500mm-1150mm
180284	BN1-115-290CM	2PC, 1150mm-2900mm
180864	BN-DP150x150	2Gen Pad * 4PC, 150mmx150mm

3rd Hand Suppoter BN2

- Single supporter load limit of 50kg
- 50-115cm, for supporting the installation of wall cabinets and wooden door frames
- 115-290cm, for supporting drywall work on ceiling
- 150x150mm support pads
- Press to lift, push to return



Model #	Spec	Description
180291	BN2-50-115CM	2PC, 500mm-1150mm, 1*carry bag
180307	BN2-115-290CM	2PC, 1150mm-2900mm, 1*carry bag

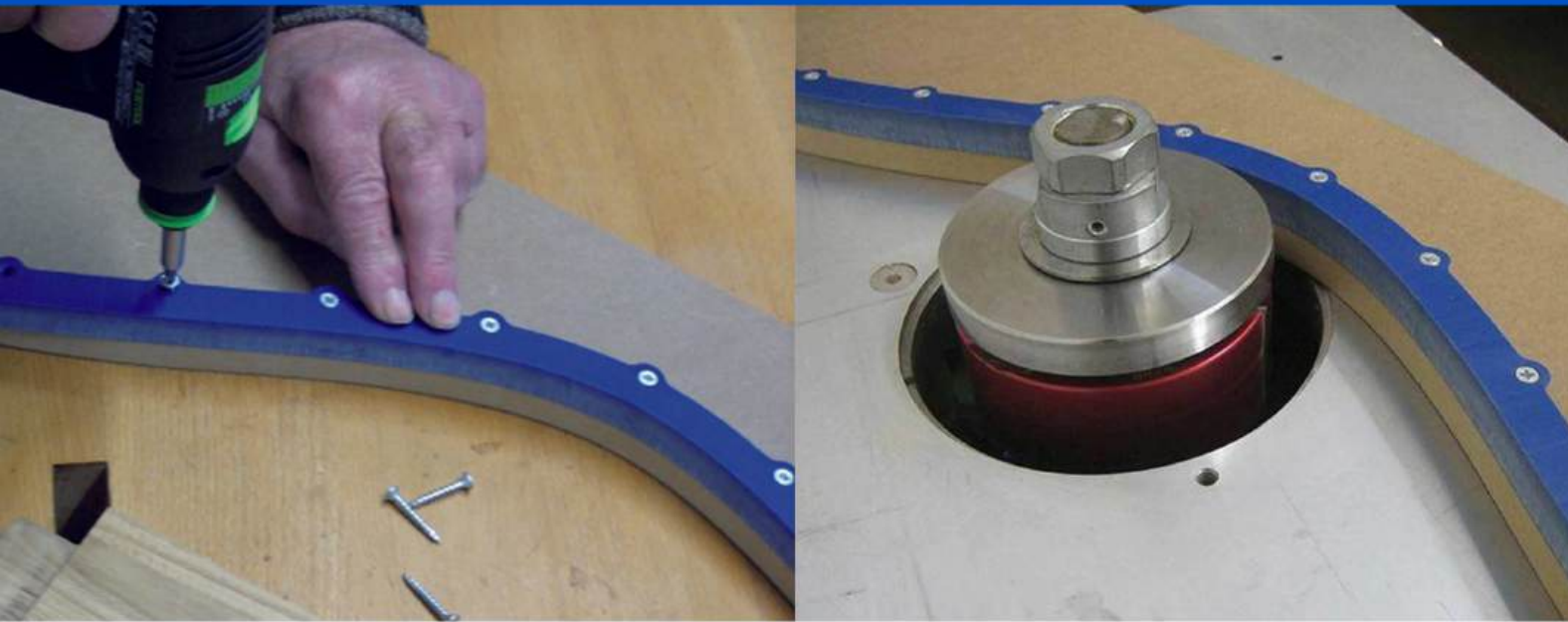

Flexible routing guide BN-FXT2M

- 2 meter length, 18mm width, for quick routing of any shape
- 3x25mm self-tapping screw installation
- Flexible plastic, bends freely without deformation
- Quickly shape design on-worksite
- For woodworking ceilings and furniture making

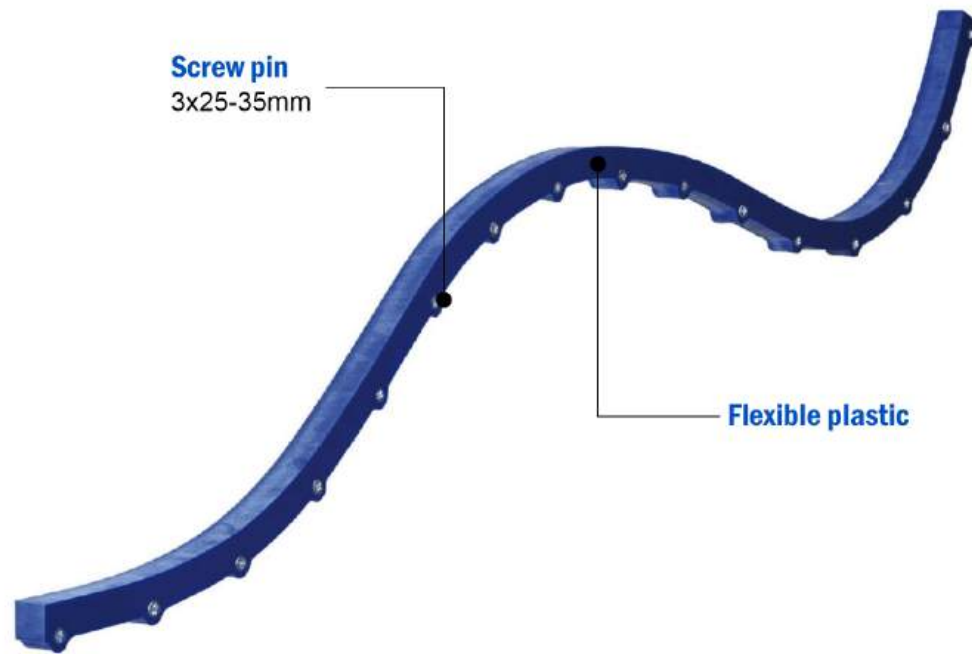

Tenon Sharpener BN-KSD14

- 16mm tenon with 14mm tapered tip, sharpening length 70mm
- 12mm shank size, low-speed gear use only
- Long-lasting / Replaceable / Sharpenable blade
- Quick sharp to improve efficiency
- Suitable for house leveling and wall squaring

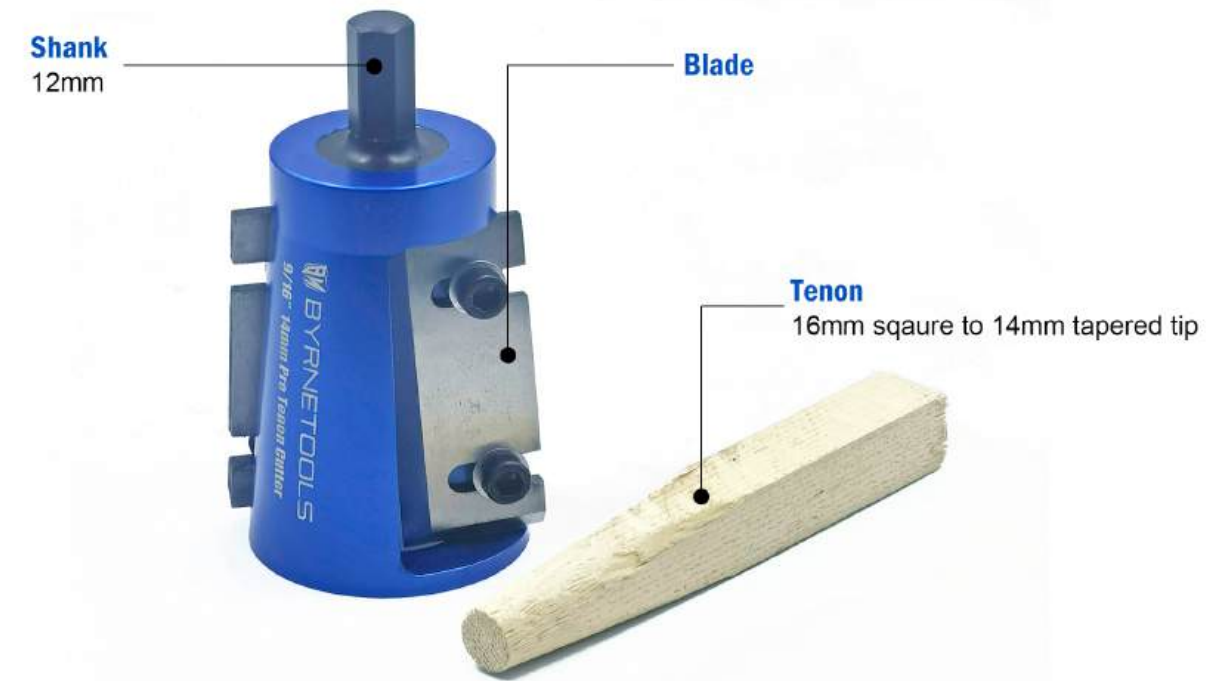

Model #	Spec	Description
180673	BN-FXT2M	1PC, 18x20mm, L: 2000mm

Model #	Spec	Description
181045	BN-KSD14	1PC, D 47mm x L 90mm

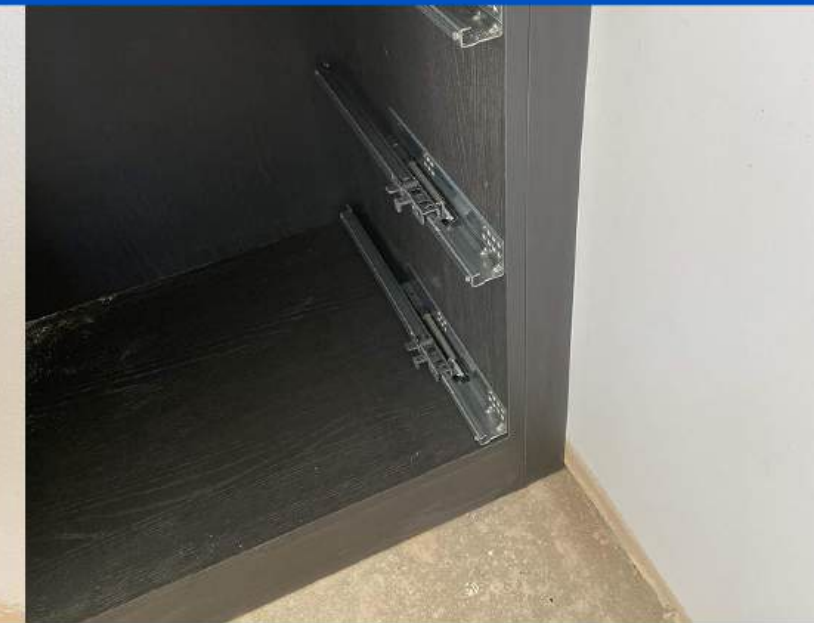
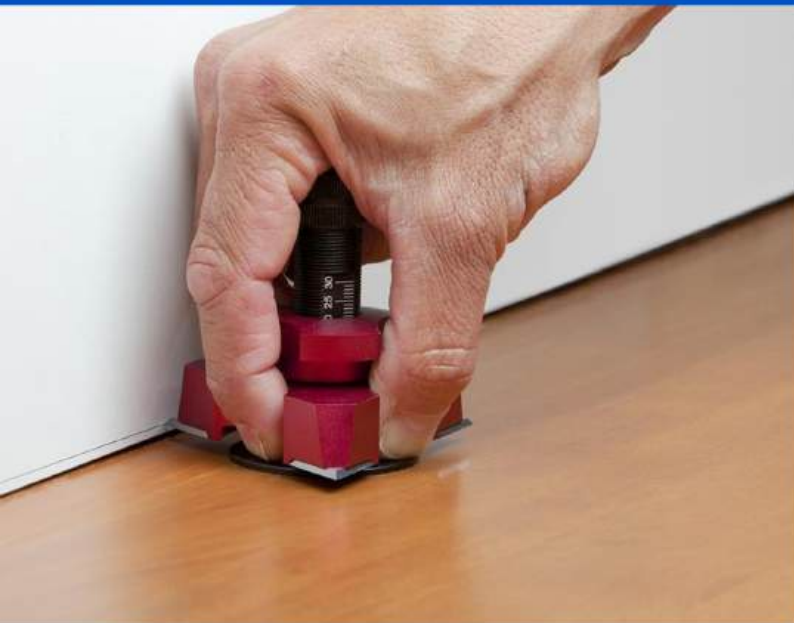

Edge Scribe BN-HX0-25

- 0-25mm height adjustment
- Precise adjustment with locking nut
- One hand operation
- Alloy blade creates clear lines on the material, making cutting easier
- Suitable for furniture edging work

Scribe Jig BN-JIGS18/3

- Quick installation, easy scribing
- 18mm board
- ABS plastic
- Suitable for furniture edging work

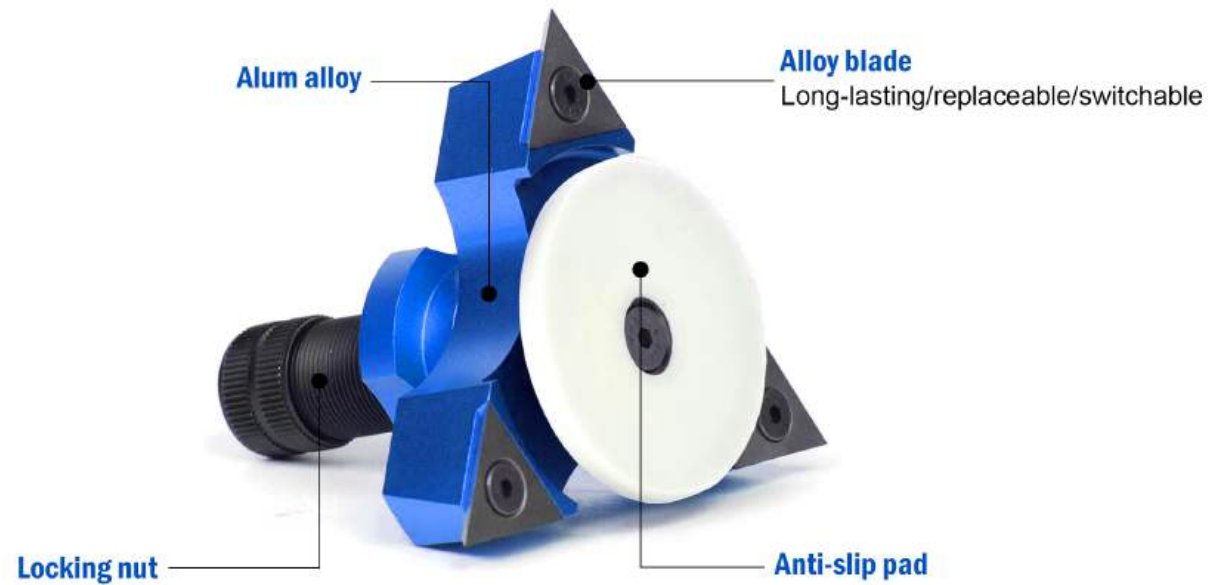

Model #	Spec	Description
180697	BN-HX0-25	1PC. 0-25mm height adjustment

Model #	Spec	Description
180352	BN-JIGS18/3	3PC, 18 mm
	843/1	1PC pencil scribe, 1PC 7.2mm pencil



Carpenter Pencil BN-QB

- 2.0-2.8mm mechanical pencil
- Comfortable grip, flexible pressing, easy lead advancement and retraction
- Built-in sharpener
- Hook design for convenient storage and portability



2.0 Carpenter Pencil BN-QB2.0



Model #	Spec	Description
180581	BN-QB2.0	1PC, L146mm

2.8 Long-life Carpenter Pencil BN-QB2.8



Model #	Spec	Description
181021	BN-QB2.8	1PC, L177mm

2.0 Lead BE-BX2.0



Model #	Spec	Description
180819	BE-BX-H2.0MM	2B*black, 12leads/box
180826	BE-BX-SS2.0MM	2B*b/r/y, 12leads/box
180833	BE-BX-B2.0MM	2B*white, 12leads/box

2.0 Lead BE-BX2.8



Model #	Spec	Description
180789	BE-2HBX-H2.8MM	2H*black, 6leads/box
180789	BE-BX-H2.8MM	2B*black, 6leads/box
180802	BE-BX-S2.8MM	2B*b/r, 6leads/box
180796	BE-BX-SS2.8MM	2B*b/y/r, 6leads/box



Oscillators Blade BIM/HCS

- STARLOCK design with depth markings
- Enables quick installation and removal, ideal for cutting complex-shaped workpieces
- Sharp teeth with stable durability
- Bimetal: Cuts soft metals, plastics, and wood
- High-carbon steel: Cuts wood and plastics
- Fit: Bosch/Fein/Milwaukee/Ridgid/Makita/Rckwell/Festool/Devon/Flex/Worx/Dongcheng



BE-BIM313444/3

*BIM



Model #	Description
180314	3PC, 31mm/34mm/44mm各1支

BE-BIM3490/3

*BIM



Model #	Description
180321	3PC, 34x90mm

BE-BIM4490/3

*BIM



Model #	Description
180338	3PC, 44x90mm

BE-BIM31120/3

*BIM



Model #	Description
180314	3PC, 31x120mm

BE-HCS3240/3

*HCS



Model #	Description
180543	3PC, 32x40mm

BE-HCS3255/3

*HCS



Model #	Description
180550	3PC, 32x55mm



Universal Jig Saw Blade BE-244D/5

- HCS material, 100mm in length, with cross-cut sharp teeth
- Ultra-narrow design for curving cut
- Head treatment, high hardness, and excellent wear resistance
- Sharp teeth, clean cutting edge, strong toughness, and resistant to breakage
- Fit: Soft and hard wood/PVC/Partical board/Fiberboard

Fine Jig Saw Blade BE-101B/5

- HCS material, 100mm in length, with cross-cut sharp teeth
- Ultra-narrow design for curving cut
- Head treatment, high hardness, and excellent wear resistance
- Clean and splinter-free cut
- Fit: Coated board/Veneered board/Fine cut required boards



Model #	Spec	Description
180871	BE-244D/5	5PC, L100mm

Model #	Spec	Description
180888	BE-101B/5	5PC, L100mm



Hammer Drill Bit BE-CJZD

- Made of 40Cr steel and YG8 alloy steel
- Four cutting blades, tough on rebar, sharp cutting
- Large grooves for efficient chip removal.
- SDS-PLUS shank
- Fit: concrete, rock, marble, and brick walls



Model #	Spec	Description
180970	BE-CJZD06160/1	1PC, 6mm, L: 160mm
180987	BE-CJZD08160/1	1PC, 8mm, L: 160mm
180994	BE-CJZD10160/1	1PC, 10mm, L: 160mm
181007	BE-CJZD12160/1	1PC, 12mm, L: 160mm
181038	BE-CJZD14160/1	1PC, 14mm, L: 160mm



Conneting Rod M6-BO 6/10

- 6/10mm connecting rod for attaching cutting discs, saw blades, and polishing wheels
- Quick clamping of consumables
- Made of stainless steel, supports high-speed operation
- M6 shank for connecting drills, grinders, and pneumatic tools

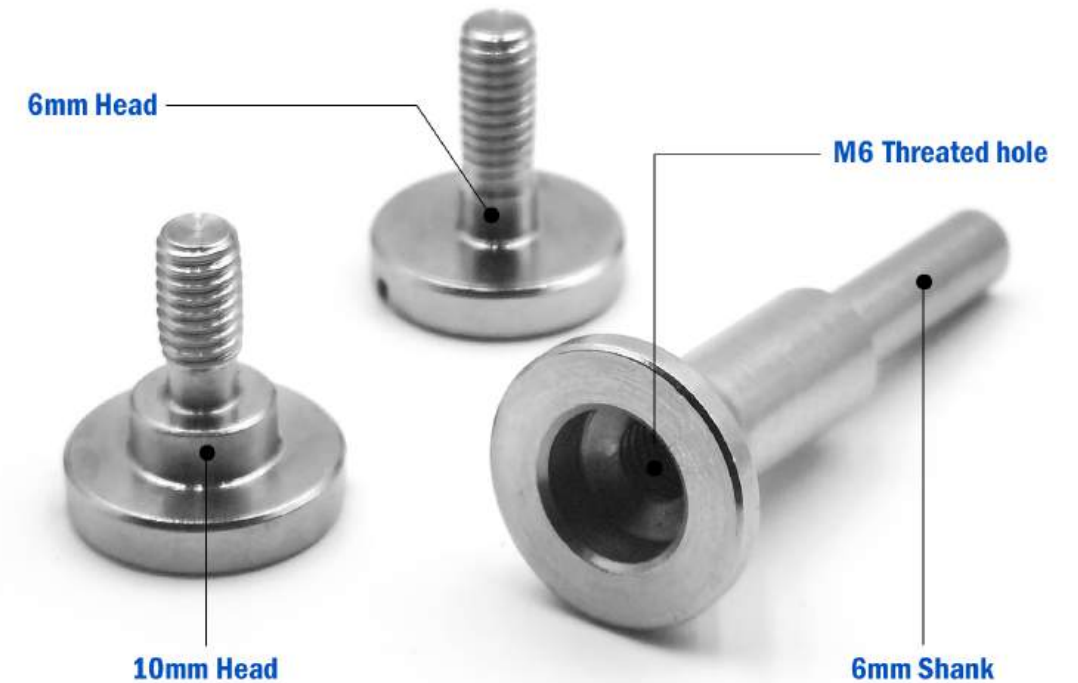

Model #	Spec	Description
180574	M6-BO 6/10	1SET, 6/10mm x L 56mm



Saw Blade(Cross-cut) 160x1.8x20/168x1.8x20mm

- High-speed steel base with alloy-tipped teeth
- Cross-cut tooth design reduces jamming, improves cutting efficiency
- Stable dynamic balance and concentricity
- Sharp teeth, clean cuts, excellent durability, worth money blade
- Fit: plywood, drywal, wood, etc.

Saw Blade(Trapezoidal/flat) BN 160x1.8x20 TF52

- High-speed steel base with alloy-tipped teeth
- Trapezoidal/flat tooth design ensures clean and splinter-free cuts
- Stable dynamic balance and concentricity
- Sharp teeth, clean cuts, excellent durability, worth money blade
- Fit: Laminate/HPL/Melamine boards/Coated panels



Cross-cut design
28/40T

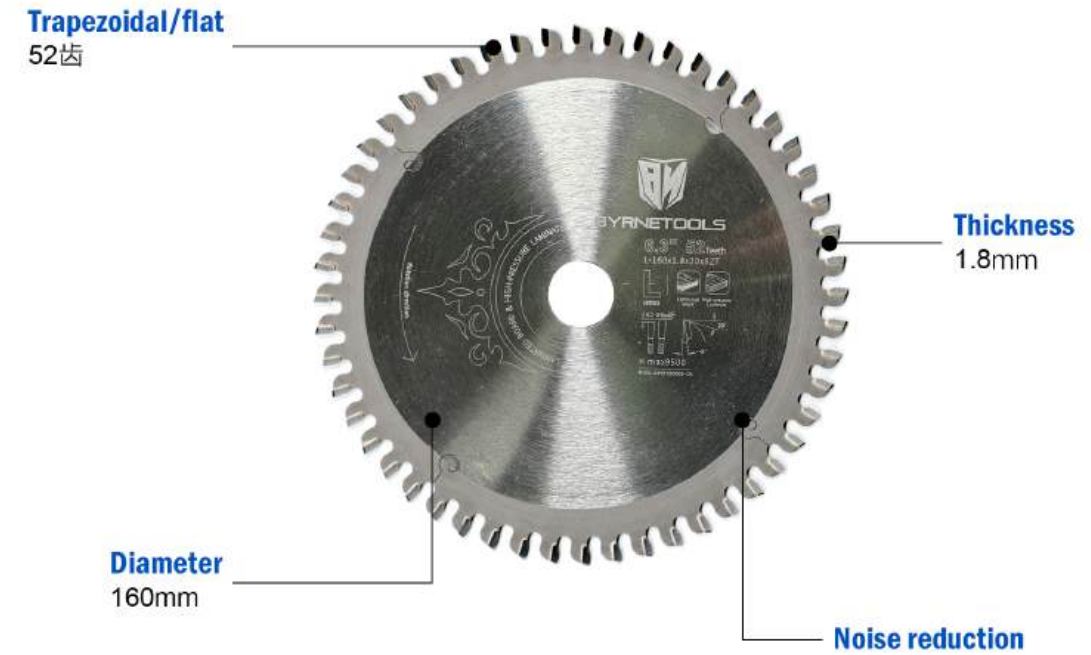

Model #	Spec	Description
180604	BN 160x1.8x20 W28	1PC, 160x1.8x20 W28
180611	BN 160x1.8x20 W40	1PC, 160x1.8x20 W40
180628	BN 168x1.8x20 W28	1PC, 168x1.8x20 W28

Model #	Spec	Description
180642	BN 160x1.8x20 TF52	1PC, 160x1.8x20 TF52



Cabinet Leveling System A BE-A

- Adjustable foot A, ABS plastic, high strength
- Long-lasting life
- Single unit load capacity of 550kg
- Manual/electric adjustment for quick cabinet height change
- Wrench length 690mm, easily adjusts the inner foot
- Fit: Cabinets/Wardrobe



Adjustable foot A BE-A



Model #	Spec	Description
181298	BE-A52-67	Adjustable range 52-67mm, 200Pcs/Carton, include panel clips
181304	BE-A80-120	Adjustable range 80-120mm, 200Pcs/Carton, include panel clips
181311	BE-A100-140	Adjustable range 100-140mm, 200Pcs/Carton, include panel clips

Leveling Wrench A BN-ABC690



Model #	Description
181281	Manual/electric wrench, L 690mm



Cabinet Leveling System B BE-B

- Adjustable foot B, ABS recycle plastic
- Long-lasting life
- Single unit load capacity of 300kg
- Manual/ electric adjustment for quick cabinet height change
- Wrench length 690mm, easily adjusts the inner foot
- Fit: Cabinets/Wardrobe

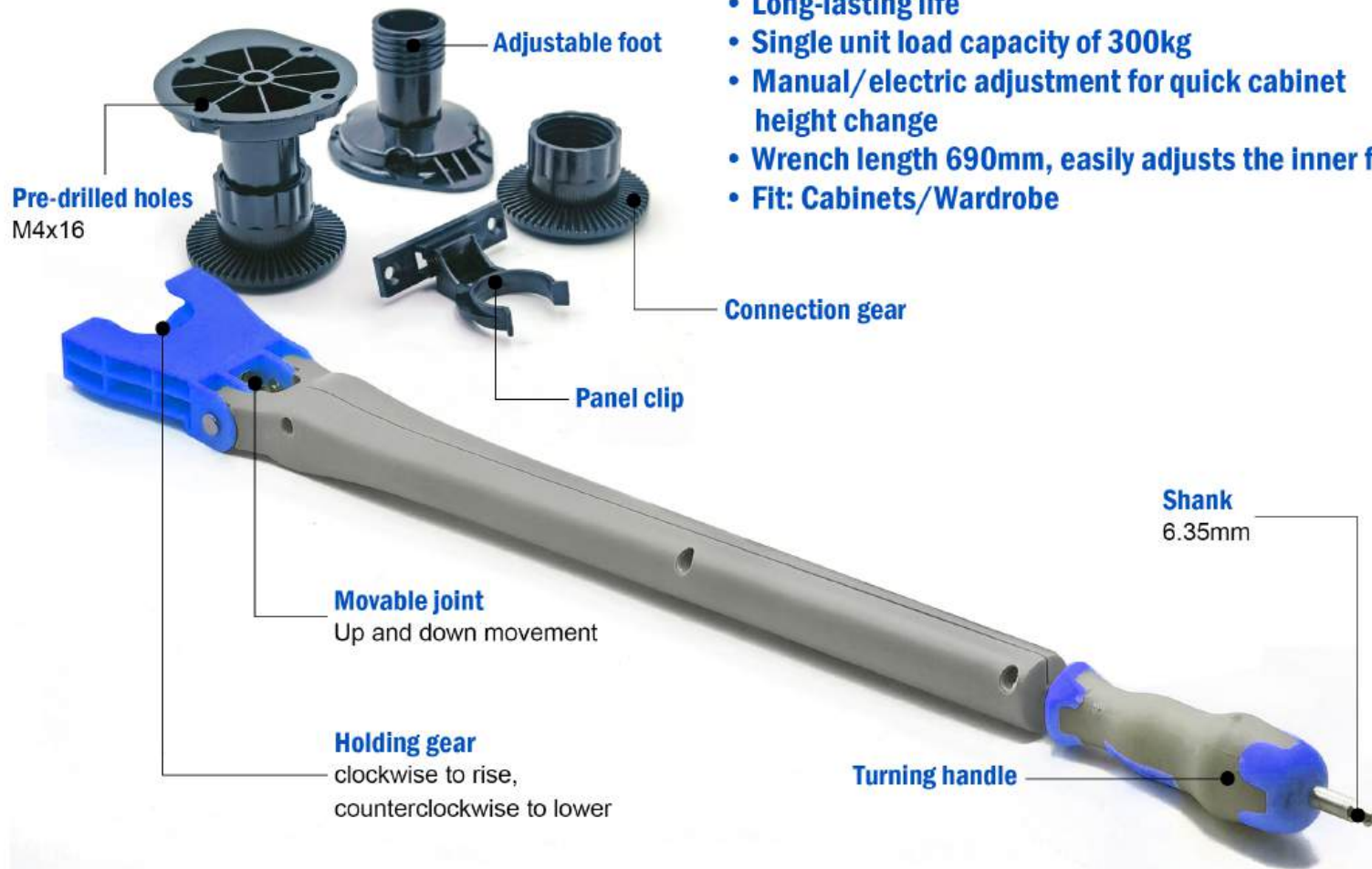

Adjustable Foot B BE-B



Model #	Spec	Description
181328	BE-B60-80	Adjustable range 60-80mm, 320Pcs/Carton, include panel clips
181335	BE-B78-98	Adjustable range 78-98mm, 320Pcs/Carton, include panel clips
181342	BE-B98-118	Adjustable range 98-118mm, 320Pcs/Carton, include panel clips

Leveling Wrench B BN-BBC688



Model #	Description
181359	Manual/electric wrench □ L 688mm

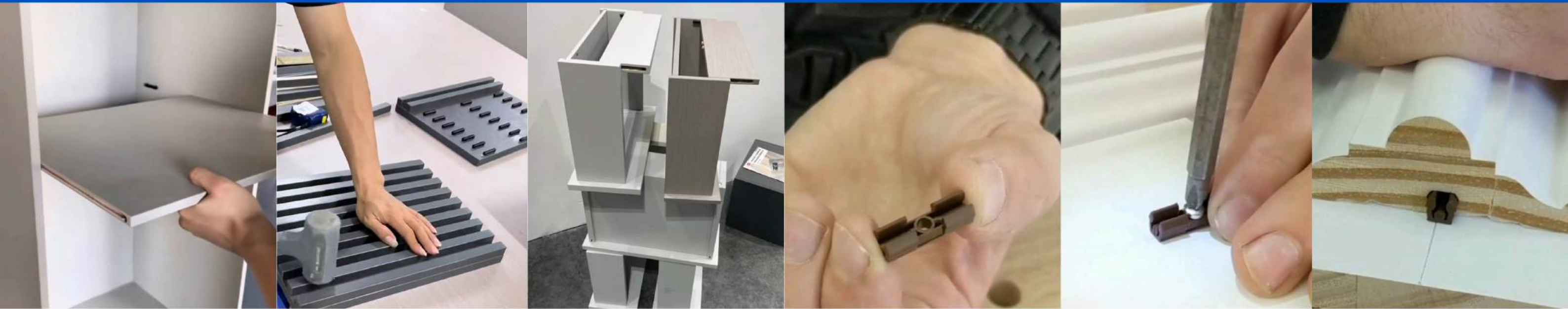

L7 Connectoer BN-L7

- Detachable hidden furniture connector for quick installation
- Fix the connector to the board , and mill the other board with a special bit for connection
- ABS plastic, with reinforced connection components, super strong tensile strength
- Fit: Furniture shelves/Drawers/Grids installation

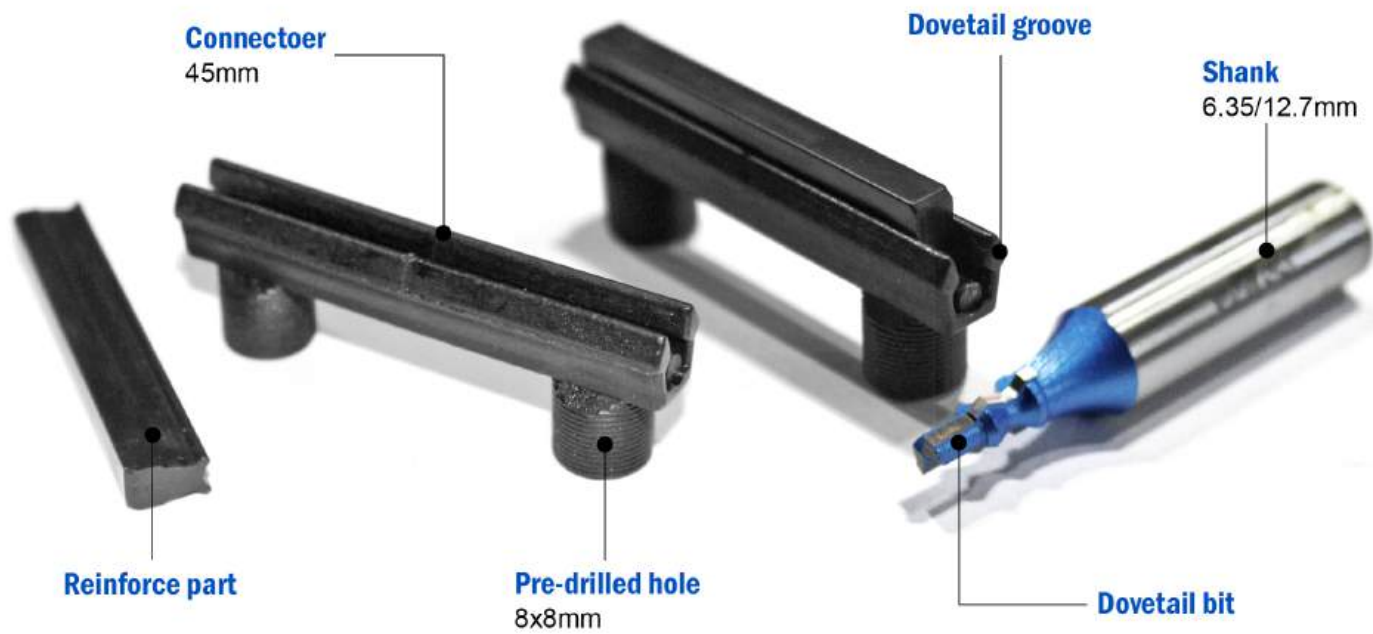

Model #	Spec	Description
180666	BN-L7	1PC*connector, 1PC*reinforce part, 45x15x8x7.35mm
180765	BE-L7*6.35	1PC, shank6.35mm
180772	BE-L7*12.7	1PC, shank12.7mm

Cabinet Hidden Connector BN-GS20

- Cabinet hidden connector , length 23mm
- Fix the connector to the board , and mill the other board with a special bit for connection
- ABS plastic, easy assembly
- Fit: Furniture shelves/Drawers/Grids installation

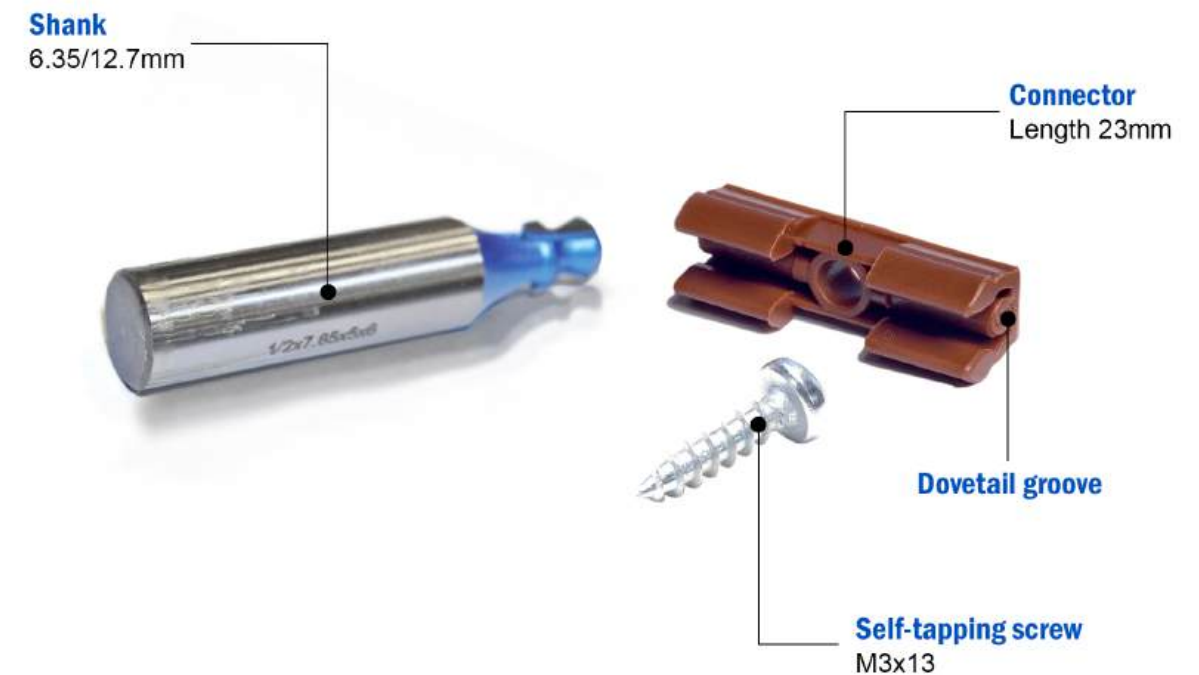

Model #	Spec	Description
180734	BN-GS20	1PC*connector, 1PC*Self-tapping screw, 23x7.3x6.7mm
180741	BE-6.35	1PC, Shank6.35mm
180758	BE-12.7	1PC, Shank12.7mm

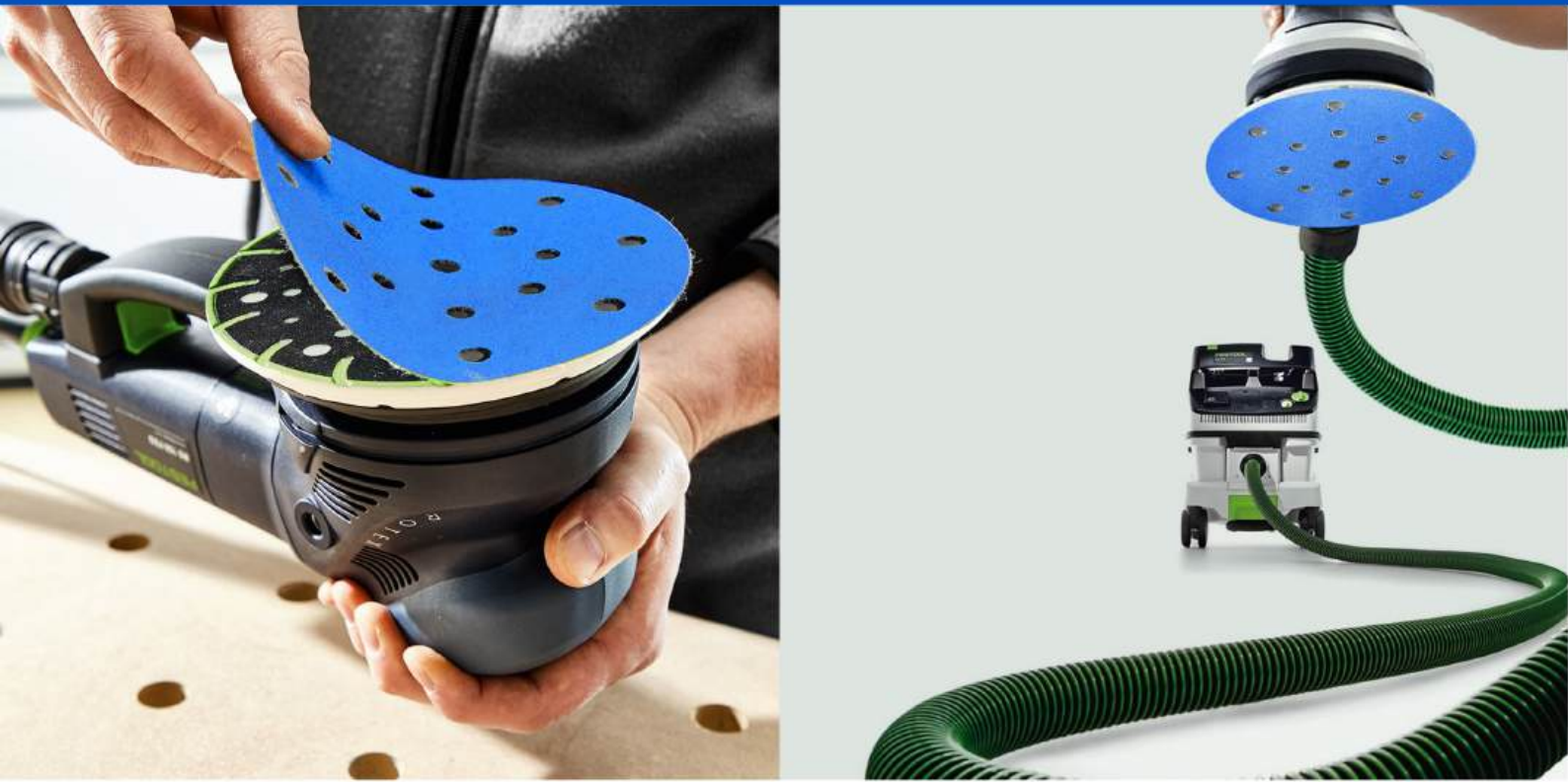

6inch 17holes Sanding Disc BE 150/17 P80-400 BLUE100

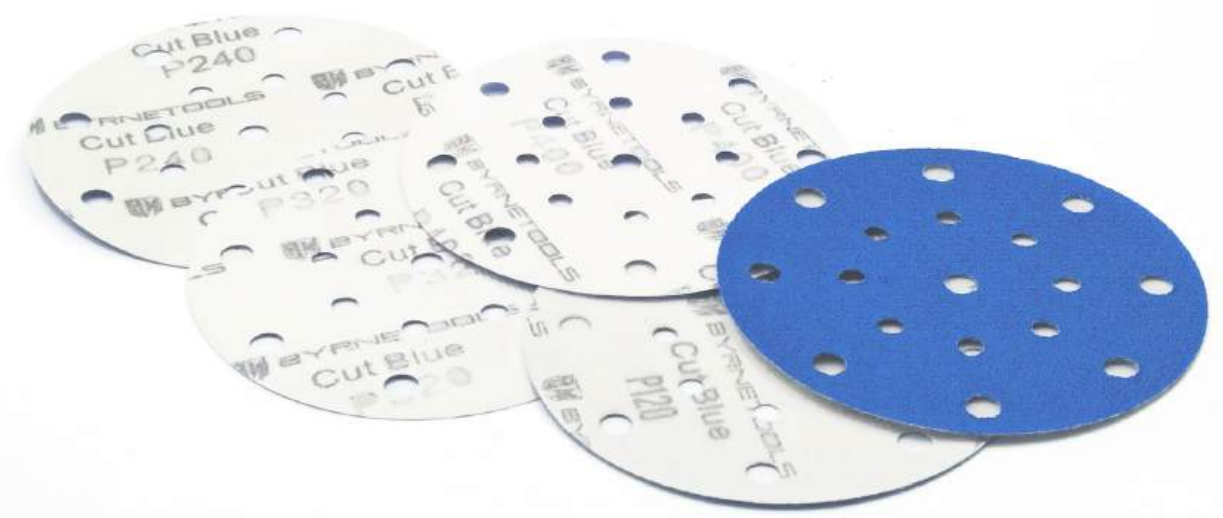

Hook&Loop Sanding Disc BE 150/17 P80-400 BLUE100

- Ceramic combined with aluminum oxide abrasives, featuring selected uniform grit
- A flexible yet sturdy substrate, ensuring that the abrasive particles do not fall off
- The special dust-proof coating extends its lifespan
- Strong adhesive hook&loop, no slip
- The uniform abrasive surface ensures a clean sanding result, reducing rework and saving time
- Fit: Woodwork/Automotive/Drywall

Model #	Spec	Description
181069	BE 150/17 P80 BLUE100	Grit 80#, diameter 150mm/6inch, 17holes, 100pcs/box
181076	BE 150/17 P120 BLUE100	Grit 120#, diameter 150mm/6inch, 17holes, 100pcs/box
181083	BE 150/17 P180 BLUE100	Grit 180#, diameter 150mm/6inch, 17holes, 100pcs/box
181090	BE 150/17 P240 BLUE100	Grit 240#, diameter 150mm/6inch, 17holes, 100pcs/box
181106	BE 150/17 P320 BLUE100	Grit 320#, diameter 150mm/6inch, 17holes, 100pcs/box
181113	BE 150/17 P400 BLUE100	Grit 400#, diameter 150mm/6inch, 17holes, 100pcs/box



Interface Pad BN-BFD150X49/1

Sanding Pad BN150HP/1



Model #	Description
180932	1PC. diameter 150mm/6inch. 49holes

Model #	Description
180925	1PC. diameter 150m/6inch, hand sanding

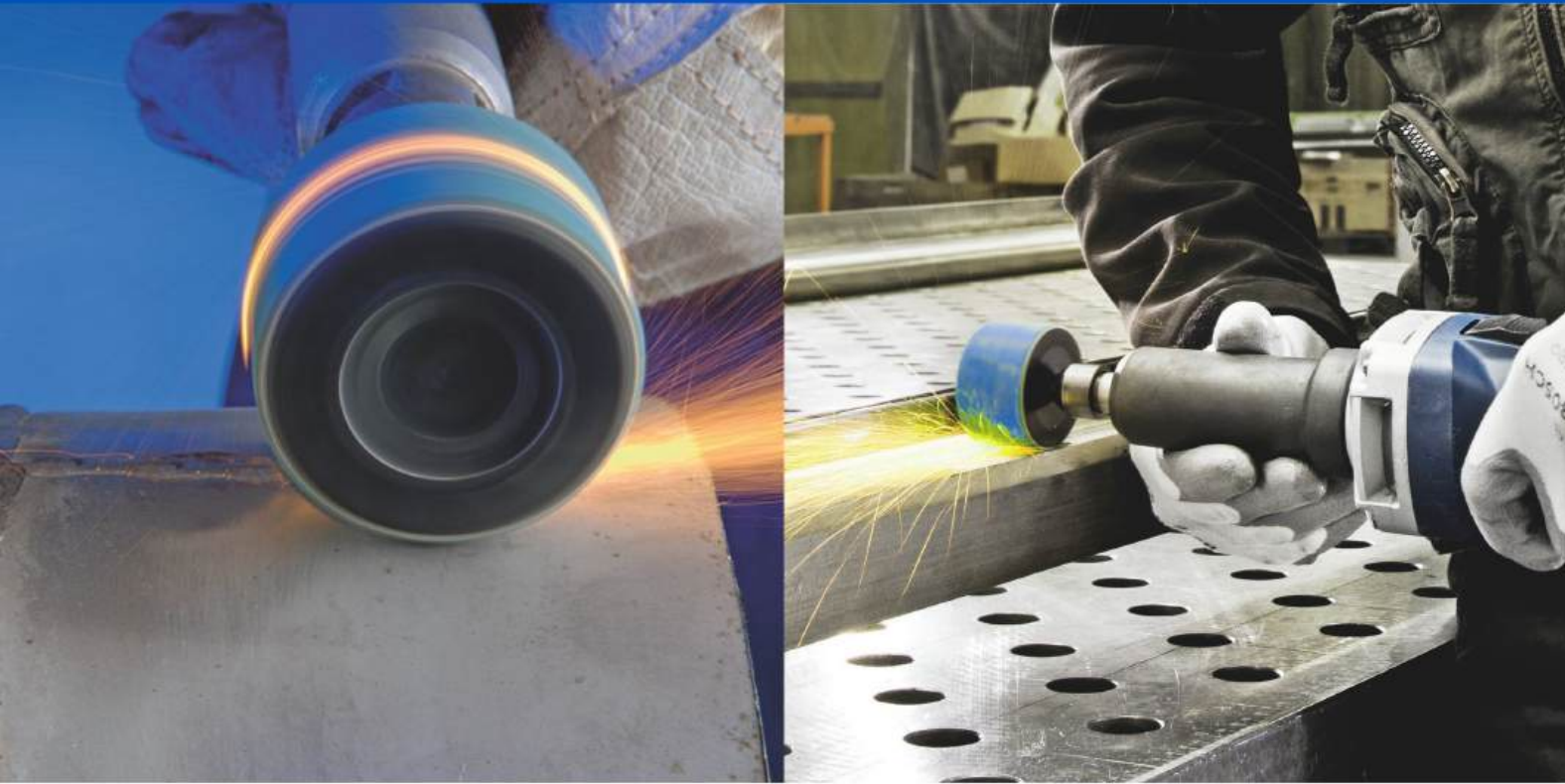

Sanding Drum/Holder BE-SG/BE-SQ

- Special drum design, with rubber expanding during spinning to securely hold the abrasive
- 6mm shank, connecting electric grinders, pneumatic grinders, and electric drills
- Made of high-quality rubber, soft and elastic, with a long service life
- Made with zirconia alumina abrasives, providing excellent material removal while maintaining sharpness
- Fit: surface grinding operations of flat surfaces, inner holes, and grooves in the metal industry



Drum Holder BE-SG



Model #	Spec	Description
180093	BE-SG1020	Shank6mm, diameter10mm, rubber height20mm, length56mm
180109	BE-SG1325	Shank6mm, diameter13mm, rubber height25mm, length60mm
180116	BE-SG1530	Shank6mm, diameter15mm, rubber height30mm, length65mm
180123	BE-SG1925	Shank6mm, diameter19mm, rubber height25mm, length60mm
180130	BE-SG2220	Shank6mm, diameter22mm, rubber height20mm, length55mm
180147	BE-SG2525	Shank6mm, diameter25mm, rubber height25mm, length60mm
180154	BE-SG3030	Shank6mm, diameter30mm, rubber height30mm, length55mm
180161	BE-SG3825	Shank6mm, diameter38mm, rubber height25mm, length65mm
180178	BE-SG4530	Shank6mm, diameter45mm, rubber height30mm, length66mm
180185	BE-SG5125	Shank6mm, diameter51mm, rubber height25mm, length60mm

砂布圈 BE-SQ



Model #	Spec	Description
180000	BE-SQ1020	Grit80#, diameter10mm, height20mm, use with drum holder
180017	BE-SQ1325	Grit80#, diameter13mm, height25mm, use with drum holder
180024	BE-SQ1530	Grit80#, diameter15mm, height30mm, use with drum holder
181366	BE-SQ1925	Grit80#, diameter19mm, height25mm, use with drum holder
180031	BE-SQ2220	Grit80#, diameter22mm, height20mm, use with drum holder
180048	BE-SQ2525	Grit80#, diameter25mm, height25mm, use with drum holder
180055	BE-SQ3030	Grit80#, diameter30mm, height30mm, use with drum holder
180062	BE-SQ3825	Grit80#, diameter38mm, height25mm, use with drum holder
180079	BE-SQ4530	Grit80#, diameter45mm, height30mm, use with drum holder
180086	BE-SQ5125	Grit80#, diameter51mm, height25mm, use with drum holder